

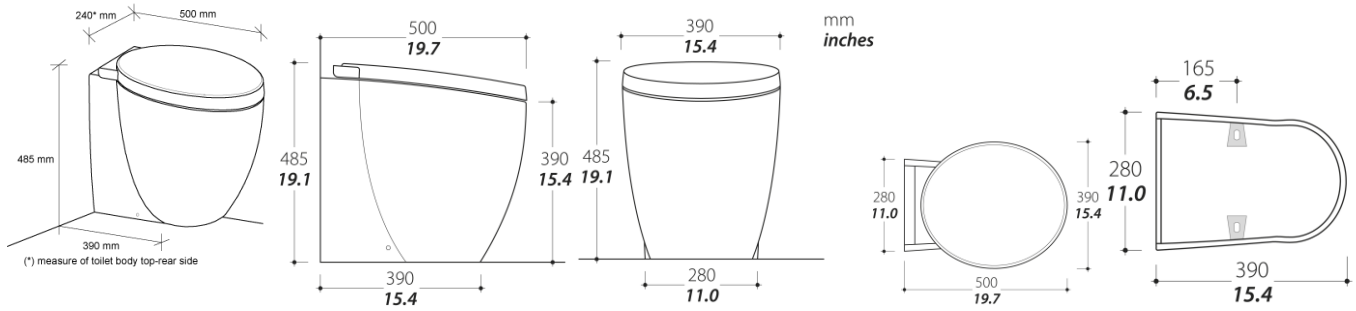

PRODUCT INFORMATION SHEET

PRIVILEGE



Product line	Design line
Collection	PRIVILEGE
Code	Depending on configuration – see code chart for details

	STANDARD CONFIGURATION	OPTIONAL CONFIGURATION
Outlet pump*	MAC 11 (DC power: 12V- 24 V)	MAC11 (AC power: 220-240 V 50 or 60 Hz-110-125V 60Hz)
Seat & Cover	Thermosetting with soft closing system: Sugatsune dampers	
Color	White	Custom color: any color including gold or platinum plating
Control Panel	All-in-One 1P SFT / All-in-One 2P SFT 	Multiframe 2P SFT / Touch Multifunction SFT 
Water inlet device*	Solenoid (centralized fresh water system)	Inlet pump (single raw water system)
Bidet		- Matching bidet see <i>PIS Privilege Bidet</i> - Integrated bidet spray nozzle function with wall mounted faucet
Water consumption	0.5 / 2.7 l (0.1- 0.7 gal) per flush. The user can easily adjust the water amount.	
Weight	28.0 Kg (61.7 lb) (fully assembled)	

*see technical data for details

Technical data:

WIRE GAUGE SIZE CHART		
Distance from source* is:		
	1-2 m	>2m
12V DC	11 AWG (4.17 mm ²)	9 AWG (6.63 mm ²)
24V DC	13 AWG (2.63 mm ²)	11 AWG (4.17 mm ²)
110-125V AC 60Hz	18 AWG (0.82 mm ²)	18 AWG (0.82 mm ²)
220-240V AC 50Hz or 60 Hz	18 AWG (0.82 mm ²)	18 AWG (0.82 mm ²)

*Distance measured assumed power and ground wires

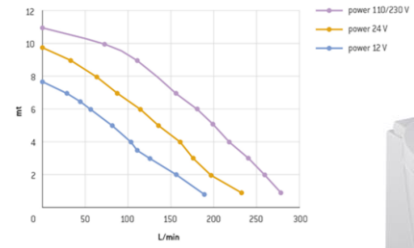

MAC 11	OUTLET PUMP	12V DC	24V DC	110-125V AC 60Hz	220-240V AC 50Hz or 60 Hz
					
Fuse recommended		40A	30A	8A	5A
Pump performance		Max 270L/min 71.3 gpm Max vertical head 11mt 36.1 ft Max horizontal distance 90 mt 295.3 ft			
Outlet Duck bill valve (male)		1.5" /required ID 1.5" (38.5 mm)			

INLET SOLENOID Centralized system	12V DC	24V DC	110-125V AC 60Hz	220-240V AC 50Hz or 60 Hz
				
Power consumption	9.5 W	10 W	6 W	6 W
Working pressure recommended	3 bar	3 bar	3 bar	3 bar
Solenoid Inlet and Outlet (threaded female)	1/2"			
Toilet inlet hose fitting (barbed)	20mm			

INLET PUMP Single system (Raw water)	12V DC	24V DC
		
Fuse	8 A	4 A
Pressure	45 PSI - 3 bar	
Water flow	12 l/min 3.17 gmp	
Toilet inlet hose fitting (barbed)	20mm	

Notes:	Install using the Fischer L-bracket provided / use stainless steel fastener
Box dimension	67cm x 50 cm x 75 cm (LxWxH)
Box weight	30 Kg
Packaging (units/pallet)	12